

M-Series

MAKING
COMPLEXITY
EASY

M
Series

MARTIN PROFESSIONAL



Martin M2GO HD™

Product Introduction

Portability without compromises



Martin M2GO HD

Martin
by HARMAN



Introduction



Welcome to the
Martin M2GO HD

The newest member of
the M-Series of controllers
from Martin Professional



Our smallest, most
powerful console ever!



M2GO HD



The new M2GO HD processing unit delivers 20 universes of DMX, Art-Net and sACN in a rugged, roadworthy package aimed at lighting designers on the go. All 20 universes are fully unlocked with no need to obtain extra licensing.

M2GO HD includes the latest graphic chipset to ensure smooth graphical effects of future software upgrades.

Four additional parameter encoders located to the right of the display can be customized to user needs and taste.

M2GO key features



Foldable touchscreen
with 4 additional
encoders

Small footprint



10 Playbacks

Martin[®]
by HARMAN

The M2GO HD offers the best of both worlds. It has its own processor while offering the smaller footprint of a typical console wing. Its rugged design will guarantee years of loyal service...



Built like no other

Industrial components



Meticulous assembly

Unmatched quality /
price



Martin[®]
by HARMAN

M2GO HD components are industrial grade and made to endure the toughness of rental and touring



Performance

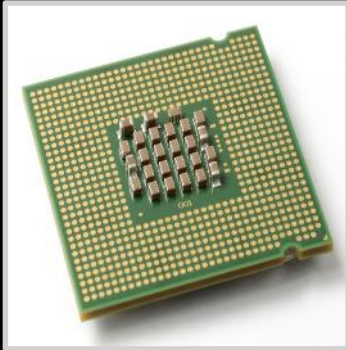

Quad core processing

Efficient
communication
protocol



Quick and snappy user
interface



The Martin M2GO HD is equipped with a 6th generation quad core processor, making operation responsive.

The user interface remains fast and responsive even if dozens of playbacks and effects are activated simultaneously.

This small footprint console can do great show thanks to its onboard 20 universe processor.

Ergonomics

Comfortable work surface



Adjustable Capacitive high resolution Touchscreen

Direct access to everything you need



Martin[®]
by HARMAN

Comfortable work surface, low profile design with proper spacing between faders and buttons, a perfect balance of buttons, faders and encoder wheels...

An adjustable-foldable touchscreen to ensure the perfect viewing angle in any ambient light condition



Carry-on anywhere



Lightweight

Portable



Airport- friendly

Martin[®]
by HARMAN

Because it is so small and lightweight, the M2GO HD can easily be moved by a single person and can be conveniently carried onboard most airlines as carry-on luggage ...



Displays

Standard capacitive multi-touch display fully adjustable angle



Dual HDMI ports for external monitors

A total of three displays

3

Martin[®]
by HARMAN



Ease of use

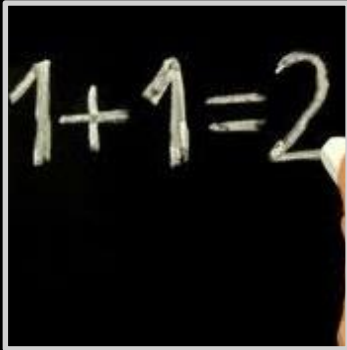

Software simplicity

Clean interface

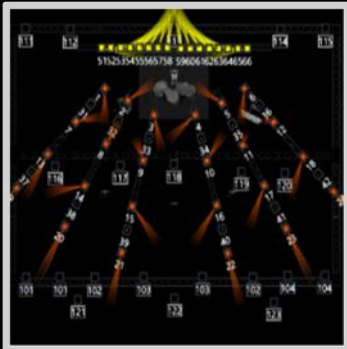

2D Plan

Martin[®]
by HARMAN

The Martin M2GO HD is the easiest lighting console you will ever learn.

Why? Because the Martin M-Series software has been designed from the ground up with a single philosophy in mind - simplicity...

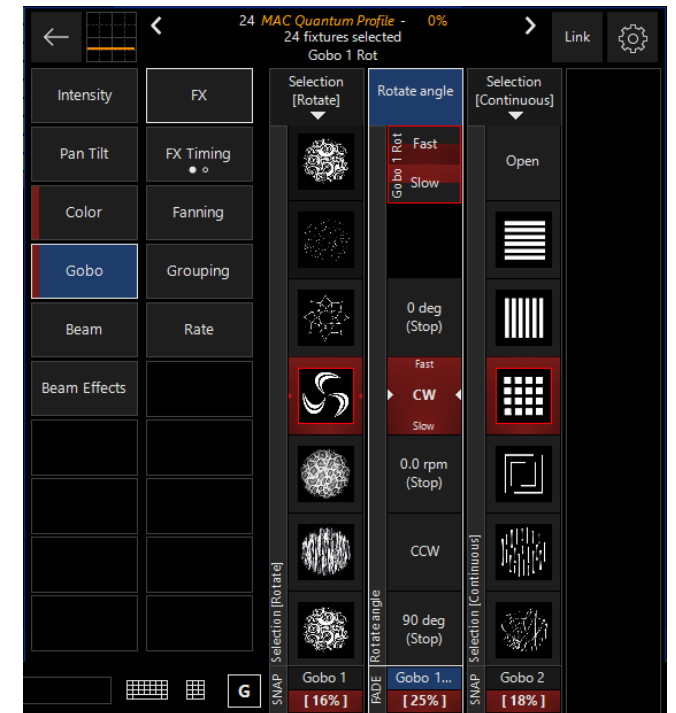

MIDI & SMPTE timecode

Standard on all
M2GO HD



MIDI

Built-in MIDI module

Built-in SMPTE module



Martin[®]
by HARMAN

The M2GO HD comes standard with an internal MIDI module to connect external MIDI devices and timecode

SMPTE Timecode ports are included for professional timecoded shows.



M2GO & DMX

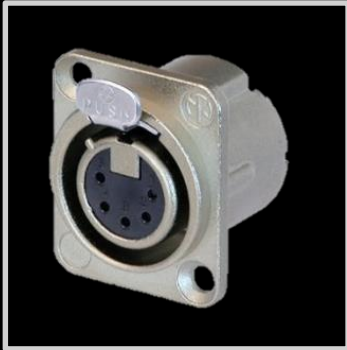

DMX / Art-Net /sACN

EtherDMX nodes



M-DMX



The M2GO HD has 4 physical DMX ports and comes standard with 20 DMX universes un-locked over Art-Net or streaming ACN
No expansion license or external processors needed

Any compatible EtherDMX nodes can be used in Art-Net or sACN protocol

M-DMX can also be use for additional DMX outputs



Included items

LED Desk lamp XLR



M2GO Power Supply
12V 5A DC XLR4P

Dust cover



Martin[®]
by HARMAN



Free Martin One-Key included



www.martinshowdesigner.com



The M2GO HD ships with a free Martin One-Key dongle

This dongle contains a free MSD Lite 1/year license as well as a lifetime M-PC Pro 64 universes license.

The perfect solution to program any shows in the comfort of home or hotel.



Lighting is about contrast...



Now you see me!
Now you don't!

It's grey for a good reason...

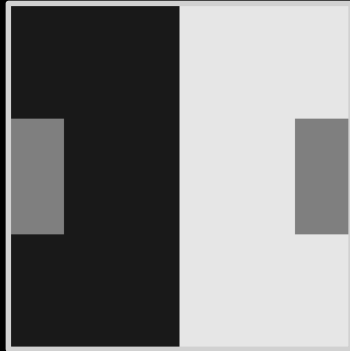

...it's all about contrast



Contrast of the user surface is of great importance. On a typical event, the stage is often very bright while the control booth is quite dark.

Under such conditions, a black surface and black buttons don't work well together. Even backlit keys can cause sight issues in such a dark environment



M-Series - A real family

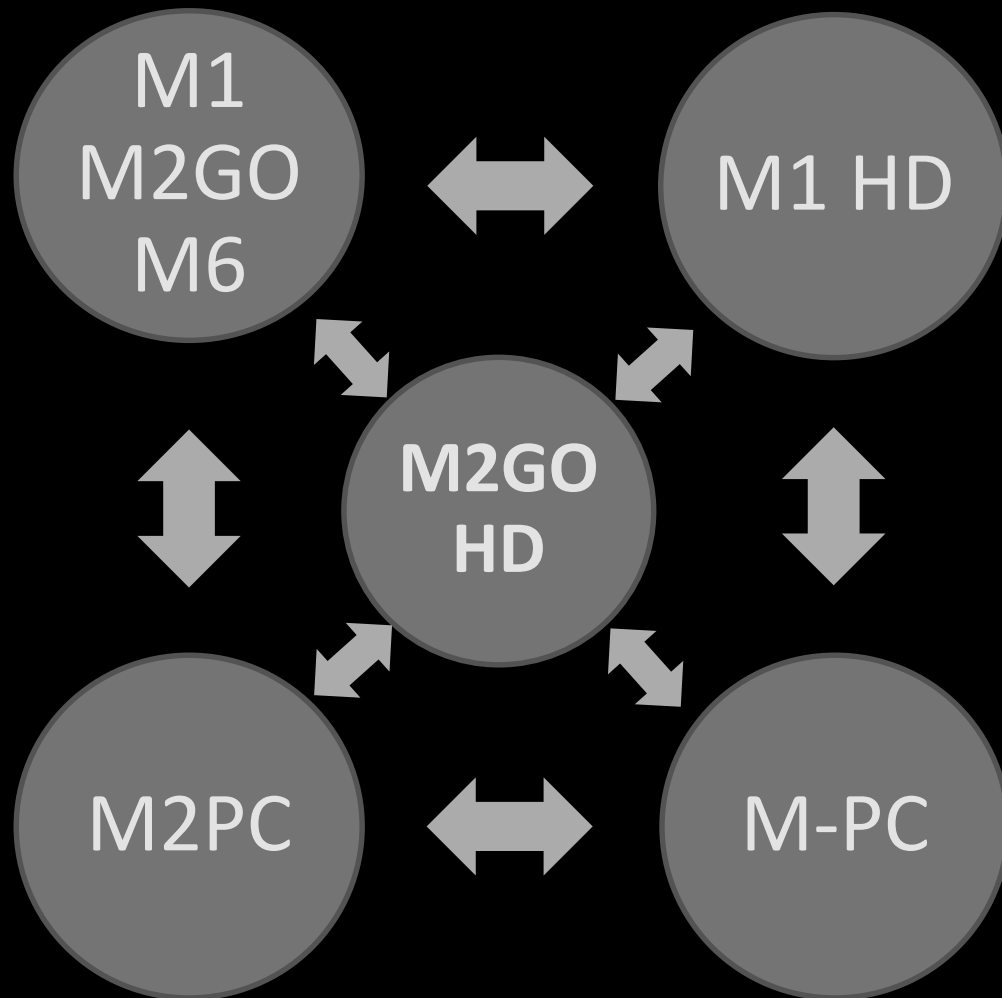

All show files made in any M-Series console or M-PC are fully compatible with the M2GO HD.

The same goes for show files made on the M2GO HD - they will load properly on any M-Series product with the same or higher software version.



M2GO HD best companions

M-Play & M-Touch



Playback II Module

Submaster module



Martin[®]
by HARMAN

The M2GO HD can benefit from several external devices to increase the number of playbacks faders and buttons.

- 90737030 Martin M-Play
- 90737040 Martin M-Touch
- 90732190 Playback II Module
- 90732170 Submaster Module

Dimensions

- Depth: 330 mm
- Width: 540 mm
- Height: 121 mm closed
- Weight: 9.5 kg*
- *Preliminary data

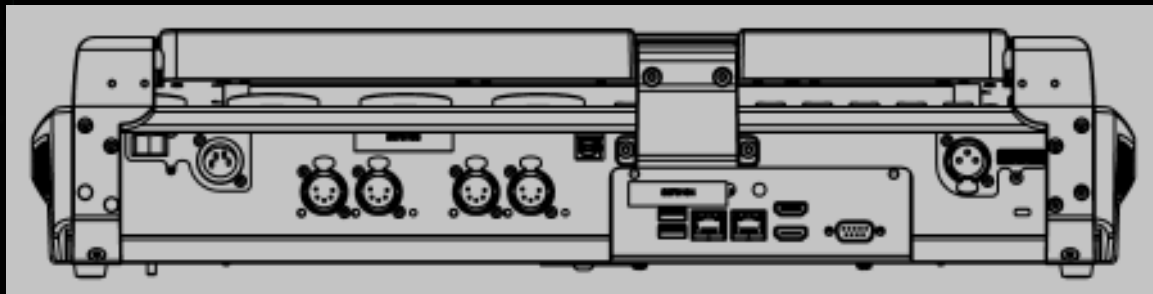
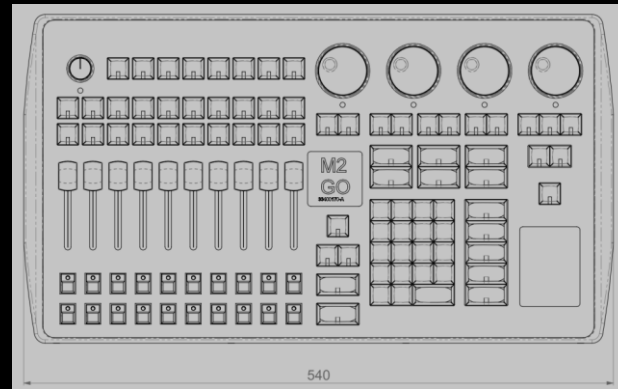

Martin[®]
by HARMAN

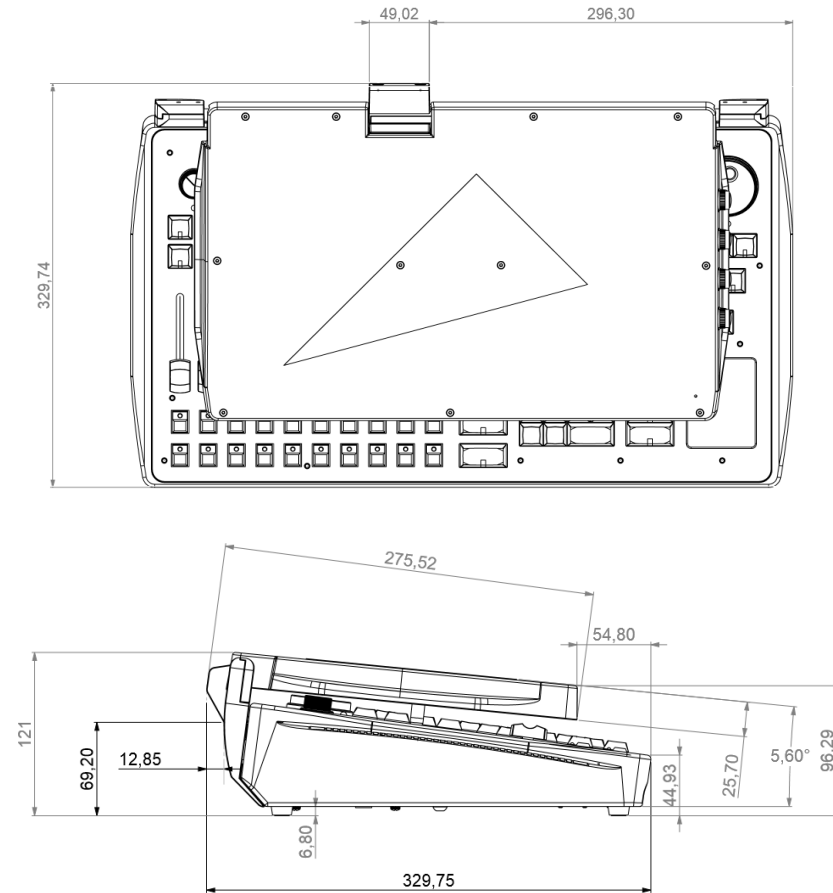

Additional photos



M2GO HD feature list



- High resolution folding capacitive multi-touchscreen
- Integrated Industrial high speed processing
- 3.5" touchscreen for fast and direct parameter access
- 8 digital encoders for parameter control
- 8 customizable function keys
- 4x DMX Universes direct from the console; up to 20 Universes via Art-Net and sACN without external processors
- Controls up to 10240 parameters
- Built-in 2D visualizer for selection and real-time visualization
- Customizable Graphical User Interface with context sensitive toolbars and integrated Help menu
- Powerful effects engine
- 1000 cuelists with fader control
- 1000 cuelists with playback control buttons
- Parallel execution of multiple cuelists
- Submaster, Groupmaster and Override functionality
- Parameter and Time-fanning functionality
- Auto update for presets and cues
- On-the-fly global timing adjustments
- M-Series Manager Software for programming and triggering via time and calendar schedules, , RS232 and IP triggers
- Multiple wing attachment (M-Series Modules)
- MaxNet synchronized programming and playback support

Availability and ordering information



- M2GO HD P/N: 90737080
- M2GO HD flightcase P/N: TBA
- M1 HD P/N: 90732090
- M1 HD flightcase P/N: TBA

- Availability Q1 2017

- Price:

- M1 HD with 40 universe, MIDI and SMPTE
- M2GO HD with 20 universe, MIDI and SMPTE

Contact your local Martin/Harman sales representative

Contact your local Martin/Harman sales representative

Prices are subject to changes without notice

* An extra Martin One-Key with M-PC Pro 64 Universes and Martin ShowDesigner Lite for one year is included at no extra charge

Q&A

Why the HD upgrade?

Processing power and speed of industrial PCs has drastically increased over the last few years, and with the launch of the M6 we designed a rugged custom glass display that allowed us to create a refresh of the M1 and M2Go with latest generation of industrial motherboards. The form factor, layout and playback features of both consoles have received really good feedback so we kept them and focused on the processing, additional I/O and display ports and screen improvements.

Can I upgrade my current M1 and M2GO to the new screen or new motherboard?

No, an upgrade is technically not possible. Metalwork, wiring, Windows licenses, UL approval are all different and an upgrade is not economically possible. However all current consoles in the market will update itself to their maximum Universe license at no charge after installing M-Series 3.60 software. M2GO supports 8 Universes, M1 up to 32.

How many Universes are possible?

M1 HD calculates 40 Universes, M2GO HD calculates 20 Universes over Art-Net and sACN. No external processing is required, all calculations are done inside the console itself.

Can I expand the Universe license?

License expansion are no longer needed for M-Series consoles, all consoles ship with their maximum Universe capabilities enabled. This is based on the speed of the processor.

Are the consoles compatible with the current M-Series product line?

Yes, the consoles can be used together with all other M-Series desks and accessories. The software is 100% identical across all M-Series devices.

Q&A

Is the screen identical to the M6 ?

The LED display is identical with the same resolution, the glass is a newer generation of capacitive touch. The screen is NOT optically bonded for improved outdoor performance. The BriteTouch screens are only used on the M6 console.

Is there a console version without the attached screens?

There are currently no plans to offer the consoles without integrated touch screens.

What is the internal screen resolution?

The consoles utilize an industrial 1366x768 HD display, LED high brightness backlight, 10 point multi touch glass touchscreen.

How many external monitors can be used?

Both consoles support two additional 1920x1080 displays. M1 HD uses DisplayPort, M2GO HD uses HDMI.

What connection ports are included?

2x Gigabit Ethernet, 2x external display, USB 3.0, USB 2.0, SMPTE, MIDI, 4x DMX Out. The M1 HD adds DMX In, 2x M-Series Module out. All ports are standard, no extra items are required.

What are the technical details of the internal processors?

Both consoles use Windows 10 Embedded, industrial motherboards, Intel Quad Core processing, 120GB SSD and 8GB RAM

Q&A - sales



What are the retail prices?

M1 HD is \$15995, M2GO HD is \$9995 in the US.

Please note that an extra Martin One-Key with M-PC Pro 64 Universes and Martin ShowDesigner Lite for 1 year is included at no extra charge.

What is included?

M2GO HD: Power Supply, IEC cable, fabric dustcover, USB recovery drive, and as a bonus a free Martin USB One-Key with M-PC Pro (64 Universes), MSD Lite 1 year subscription

M1 HD: powerCon True1 connector, fabric dustcover, USB recovery drive, and as a bonus a free Martin USB One-Key with M-PC Pro (64 Universes), MSD Lite 1 year subscription

Does Martin offer a road case?

A custom case was designed for each console. Part numbers and pricing are still being finalized.

Thank you for watching!



M2
GO HD
MARTIN PROFESSIONAL